

Varenummer: 025849160048
Beskrivelse: Norma Connect rørkobling
COMBI GRIP GL W2 Ø48,3/50 EPDM 16 bar

Mål

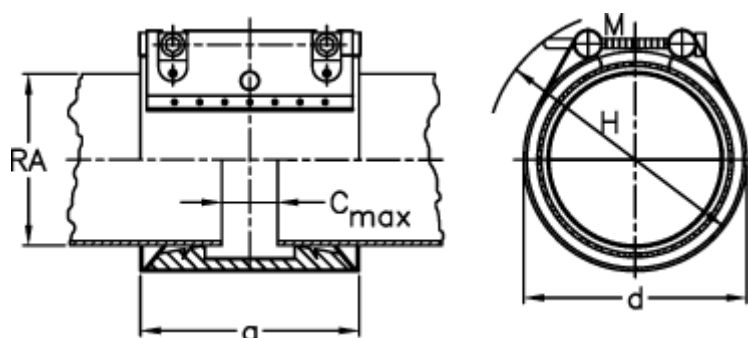

a	= 62.4	RA min-RA max metal = 47,8-49,0
C max med båndindlæg	= 8	Vægt pr stk. = 0.6
d	= 70	
H	= 90	
M (Skrue)	= M8	
Nominelt tryk (bar)	= 16	
RA	= 48,3/50,0	
RA min-RA max kunststof	= 49,5-50,5	